



CDS 101/110: Lecture 6.1

Observability Wrap-Up

Intro to Transfer Functions



October 31, 2016

Goals:

- Present simple computational study of observability.
- Hand out and discuss Midterm exam.
- Define the input/output transfer function of a linear system.
- Describe Bode plots for frequency response investigation

Reading:

- Åström and Murray, Feedback Systems-2e, Sections 9.1-9.2

Double Integrator Example

Double Integrator Model: $\ddot{x} = u, \quad y = x.$

- 1st-order equivalent: $\dot{x} = Ax + Bu$ with

$$A = \begin{bmatrix} 0 & 1 \\ 0 & 0 \end{bmatrix} \quad B = \begin{bmatrix} 0 \\ 1 \end{bmatrix}$$
$$C = \begin{bmatrix} 1 & 0 \end{bmatrix} \quad D = \begin{bmatrix} 0 \end{bmatrix}$$

Check Controllability & Observability

- $W_r = [B \quad AB] = \begin{bmatrix} 0 & 1 \\ 1 & 0 \end{bmatrix}$
- $W_o = \begin{bmatrix} C \\ AC \end{bmatrix} = \begin{bmatrix} 1 & 0 \\ 0 & 1 \end{bmatrix}$

State Feedback Controller: $u = -Kr + k_r r$

- Place poles at $\lambda_{1,2} = -\zeta\omega_0 \pm \omega_0\sqrt{\zeta^2 - 1}$
 $= -7.0 \pm 7.0i$
- $K = [98 \quad 14]$
- $k_r = -[C(A - BK)^{-1}B]^{-1} = 98$

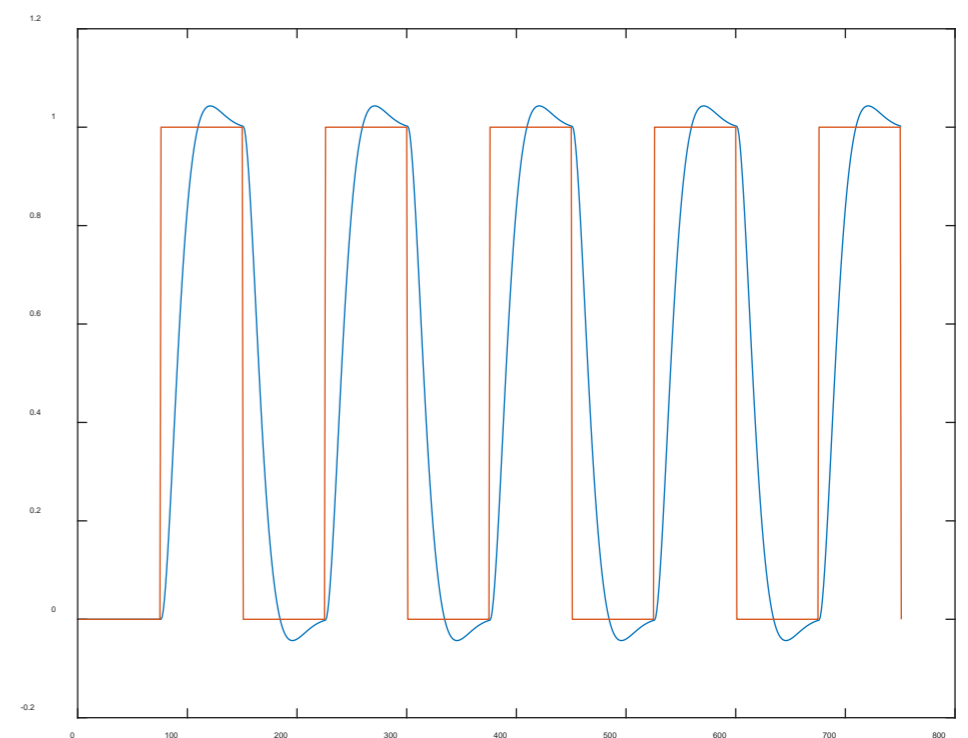
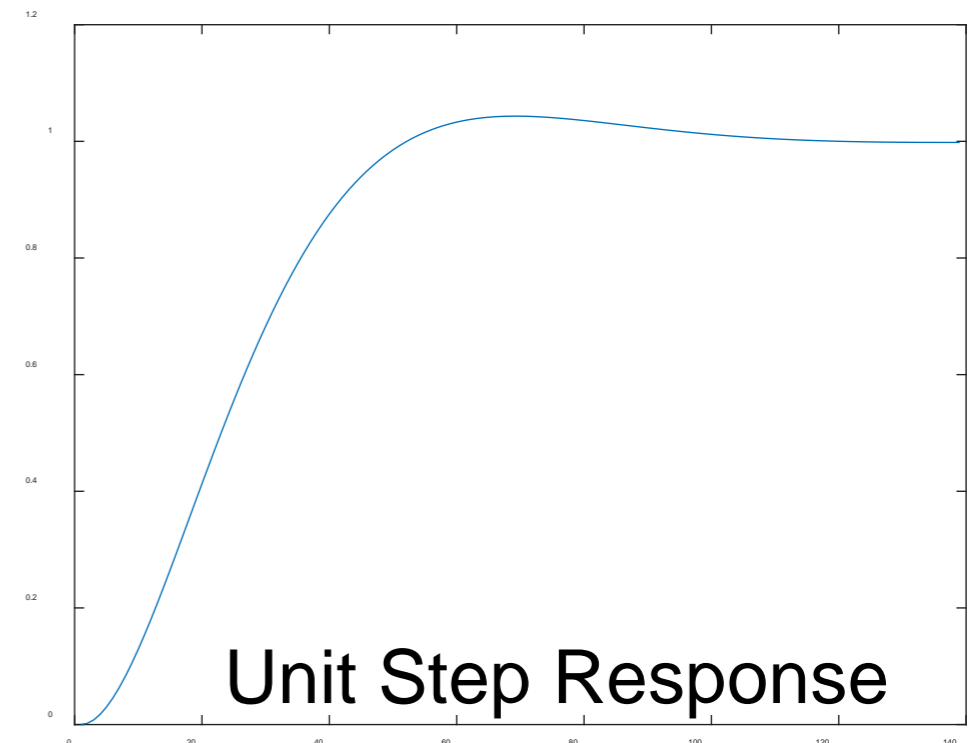

Square Wave Response

Double Integrator Example (continued)

MATLAB:

```
A=[0 1; 0 0];  
B=[0; 1];    C=[1 0];    D=[0];  
sys0=ss(A,B,C,D);
```

State Feedback Controller: $u = -Kr + k_r r$

```
FdbkPoles=[(-7 + 7i) (-7 - 7i)];  
K=place(A,B,FdbkPoles);  
BK= B*K;  
AK=A-BK;    % closed loop system  
kr=-inv(C*inv(AK)*B);  
Bref=kr*B;  
sysref=ss(AK,Bref,C,D);
```

Square Wave Reference:

```
[usquare,tsquare]=  
    gensig('square',1.5,7.5,0.01);  
[yout,tout,xout]=  
    lsim(sysref,usquare,tsquare);  
plotout=[yout usquare(:,1)];  
plot(plotout);
```

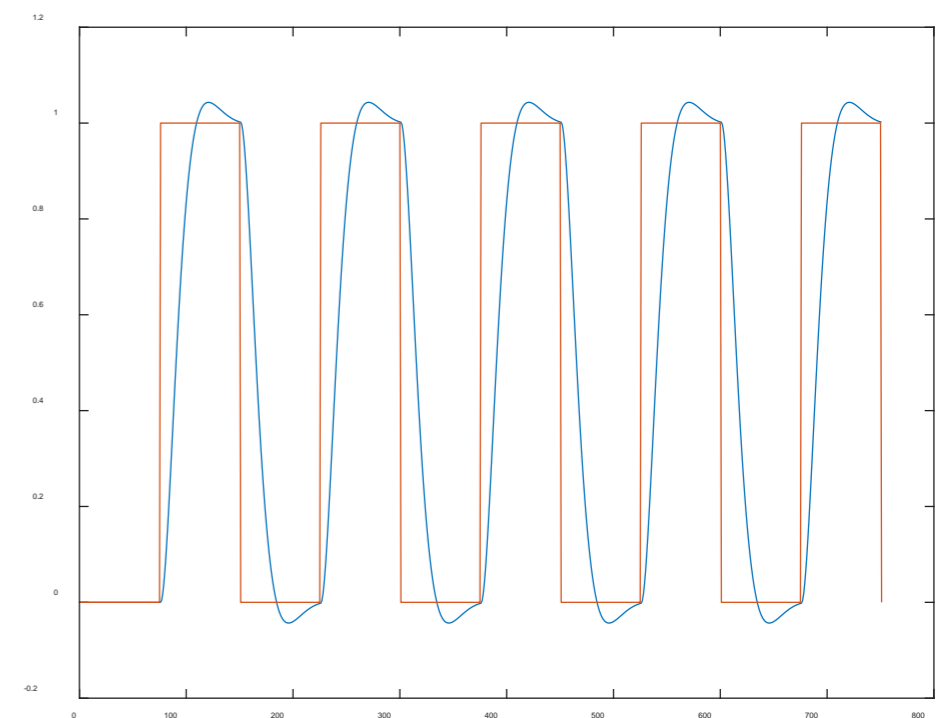
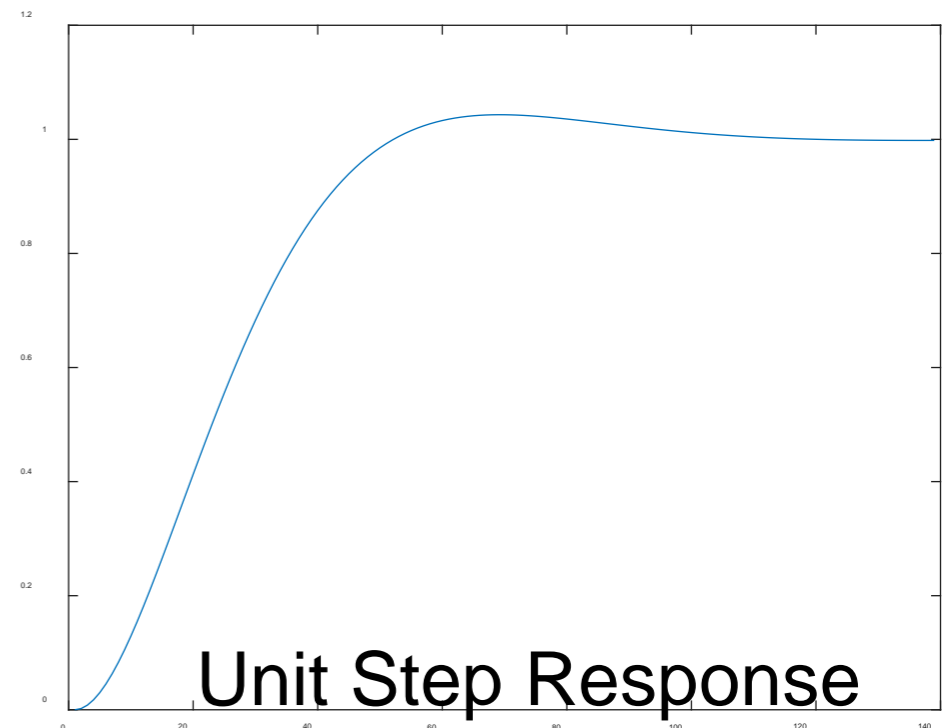

Square Wave Response

Double Integrator Example (continued)

Design an Observer: $\dot{\hat{x}} = A\hat{x} + Bu + L(y - C\hat{x})$

- Place observer poles at $\lambda_{1,2} = -\zeta\omega_0 \pm \omega_0\sqrt{\zeta^2 - 1}$
 $= -10.0 \pm 10.0i$
- To calculate L, use MATLAB: $L^T = \text{place}(A^T, C^T, \lambda_{1,2})$

```
LT=place(A',C',[-10.0+10i;-10.0-10i]);  
L=LT';
```

- Create a system whose simulation demonstrates the observer

```
LC=L*C;  
Aobs=A-LC;  
sysObs=ss(Aobs,[L B],eye(2),zeros(2,2));  
  
xh=lsim(sysObs,[yout,usquare],tout);  
allplot=[yout xh(:,1)]; (or allplot=[yout xh(:,1) xh(:,2)]);  
plot(allplot);
```

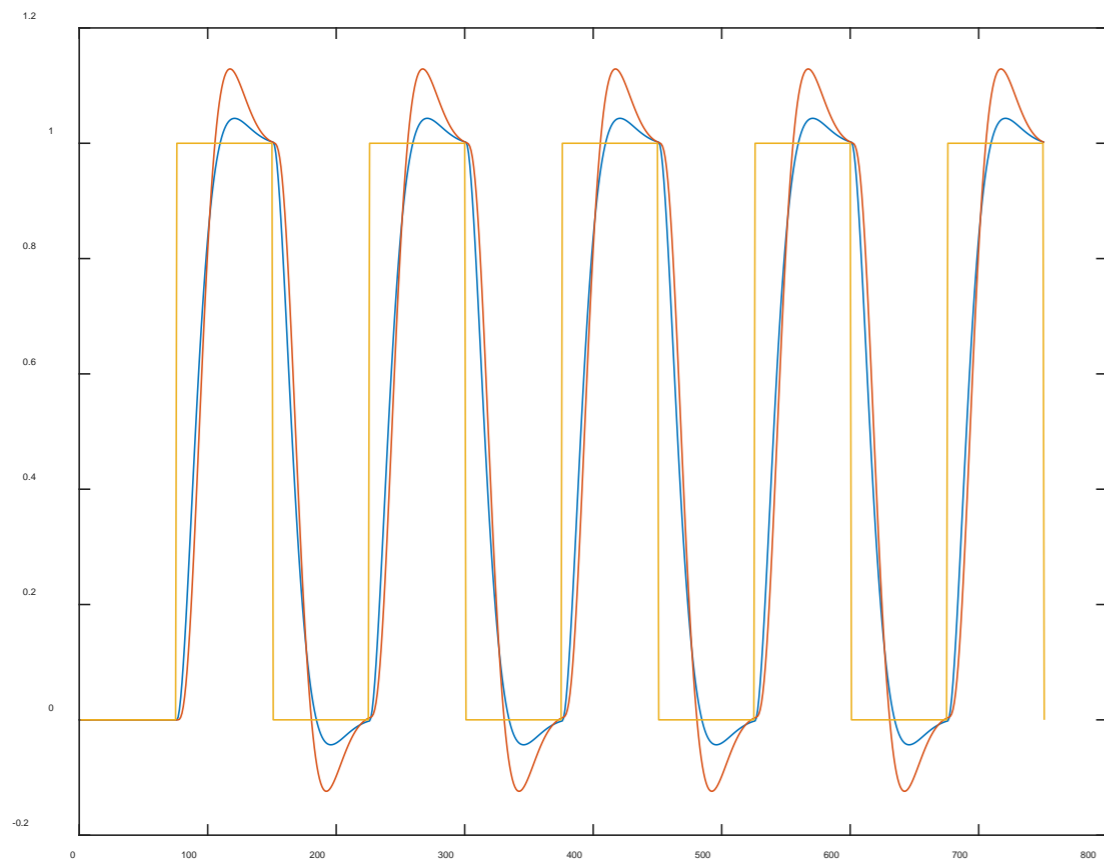

Position Estimate

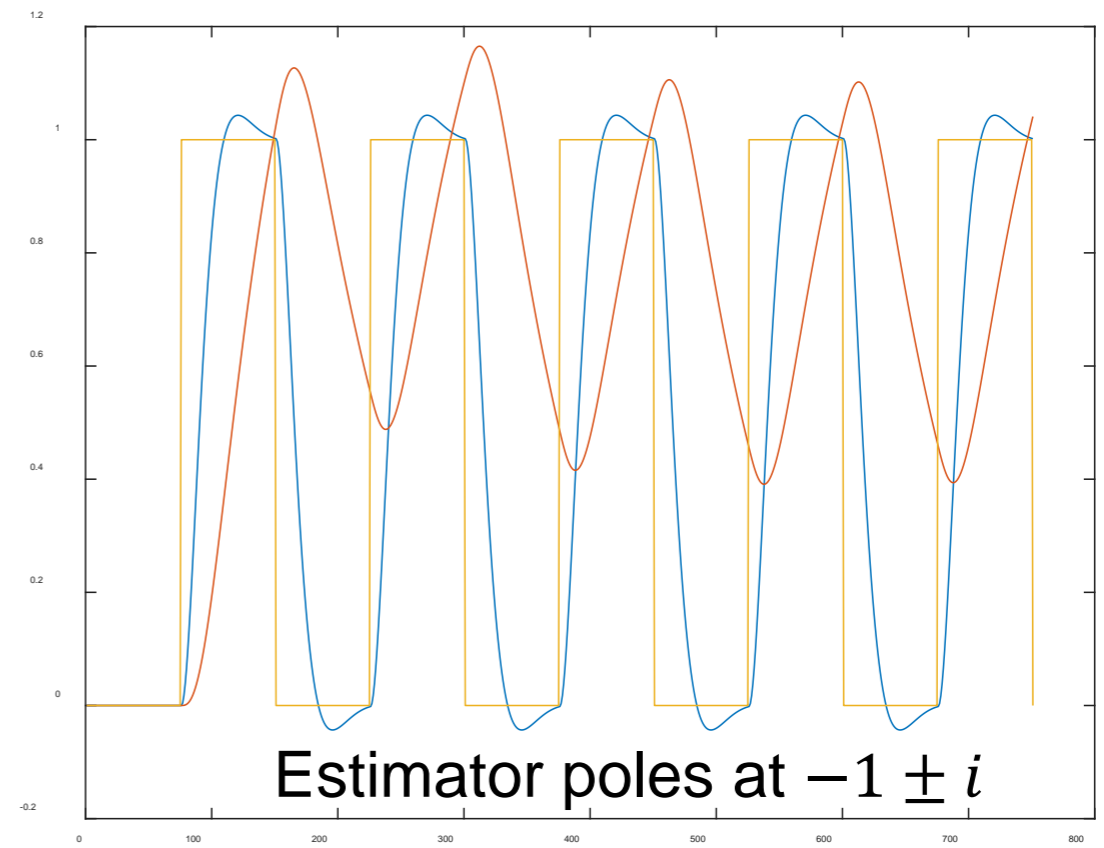

Position and Velocity Estimate

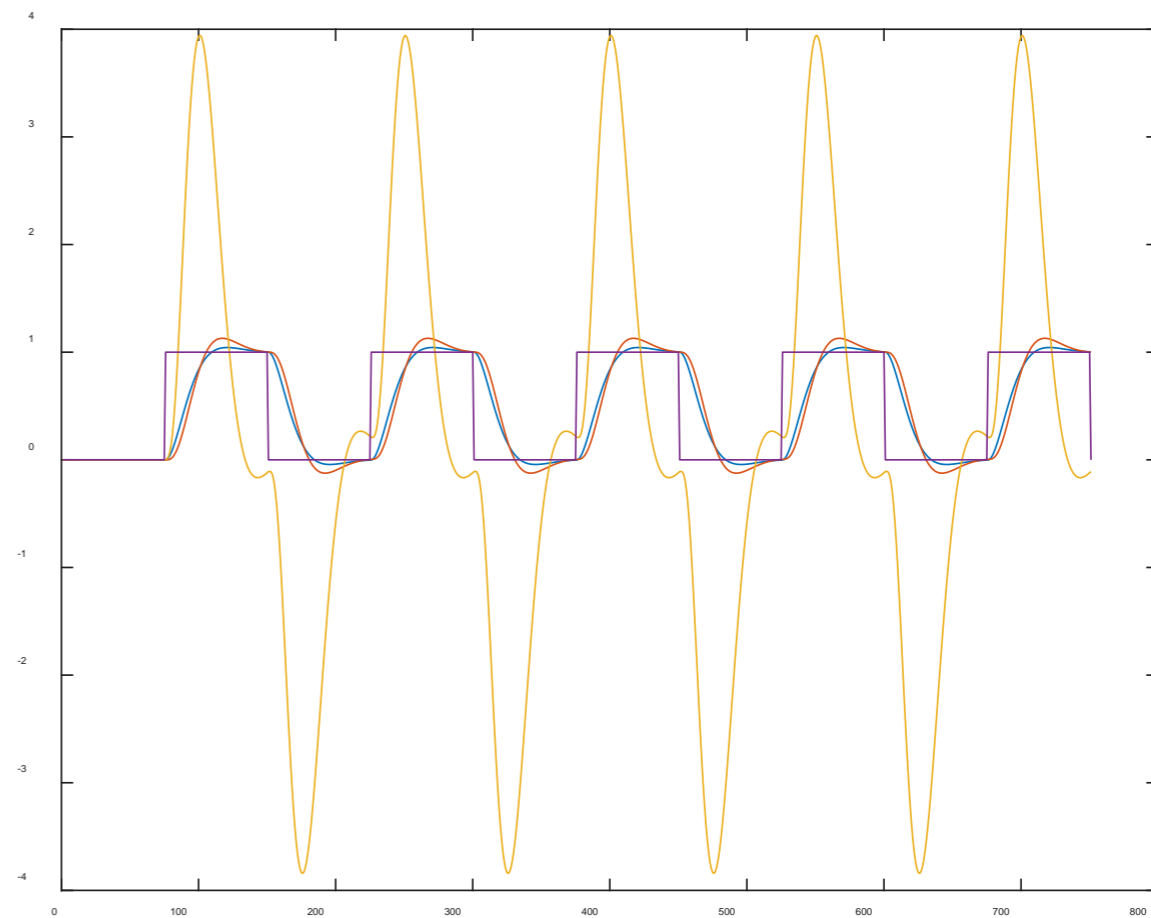

Double Integrator Example (continued)

Create a system which simulates estimated state feedback

$$\dot{x} = Ax + Bu, \quad \dot{\hat{x}} = A\hat{x} + Bu + L(y - C\hat{x}) \quad u = -K\hat{x} + k_r r$$

$$\begin{bmatrix} \dot{x} \\ \dot{\hat{x}} \end{bmatrix} = \begin{bmatrix} A & -BK \\ LC & A - LC - BK \end{bmatrix} \begin{bmatrix} x \\ \hat{x} \end{bmatrix} + \begin{bmatrix} Bk_r \\ Bk_r \end{bmatrix} r$$

In MATLAB:

```
ALCBK=A-LC-BK;
Atot=[A(1,1) A(1,2) -BK(1,1) -BK(1,2); A(2,1) A(2,2) -BK(2,1) -BK(2,2);
LC(1,1) LC(1,2) ALCBK(1,1) ALCBK(1,2); LC(2,1) LC(2,2) ALCBK(2,1) ALCBK(2,2)];
Btot=[Bref(1,1); Bref(2,1); Bref(1,1); Bref(2,1)];
Ctot=[1 0 0 0]
Dtot=[0];
systot=ss(Atot,Btot,Ctot,Dtot);
[Ytot, Ttot, Xtot]=lsim(systot,[usquare(:,1)],tsquare);

graphtot=[Ytot Xtot(:,1) Xtot(:,2) Xtot(:,3) Xtot(:,4) usquare(:,1)];
plot(graphtot);
```

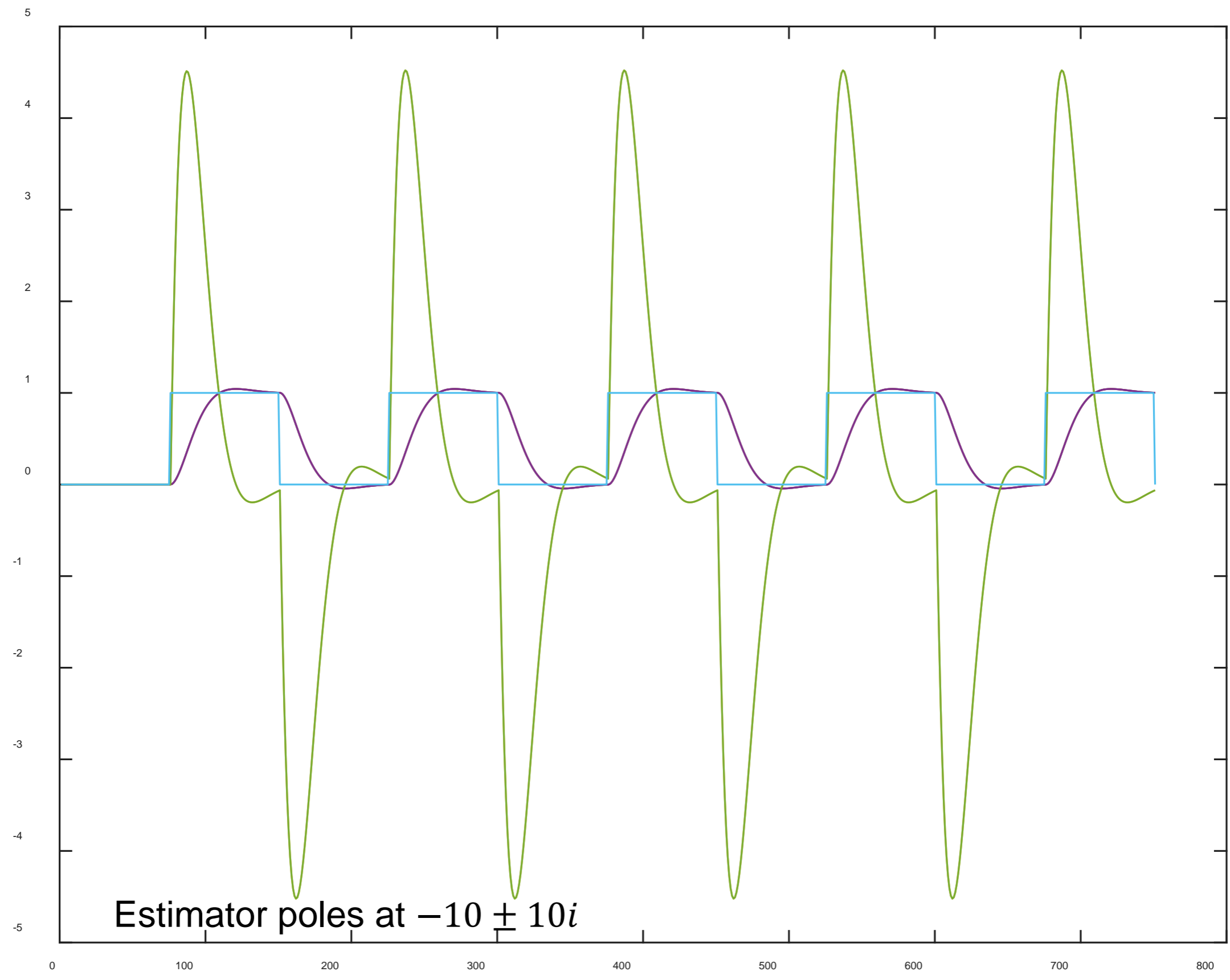

Estimator poles at $-10 \pm 10i$

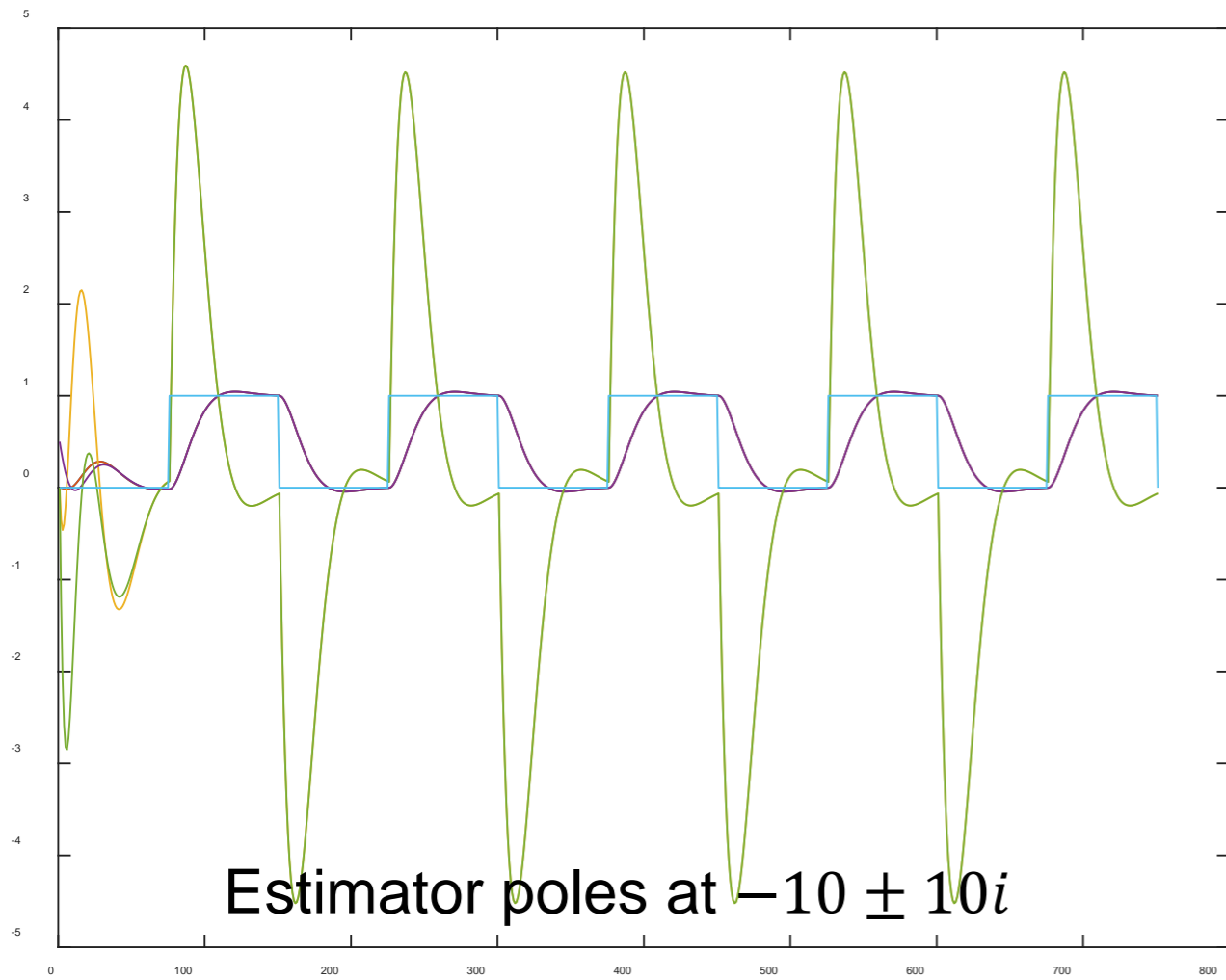

**Error in Initial
condition of $\hat{x}_1 = 0.5$**

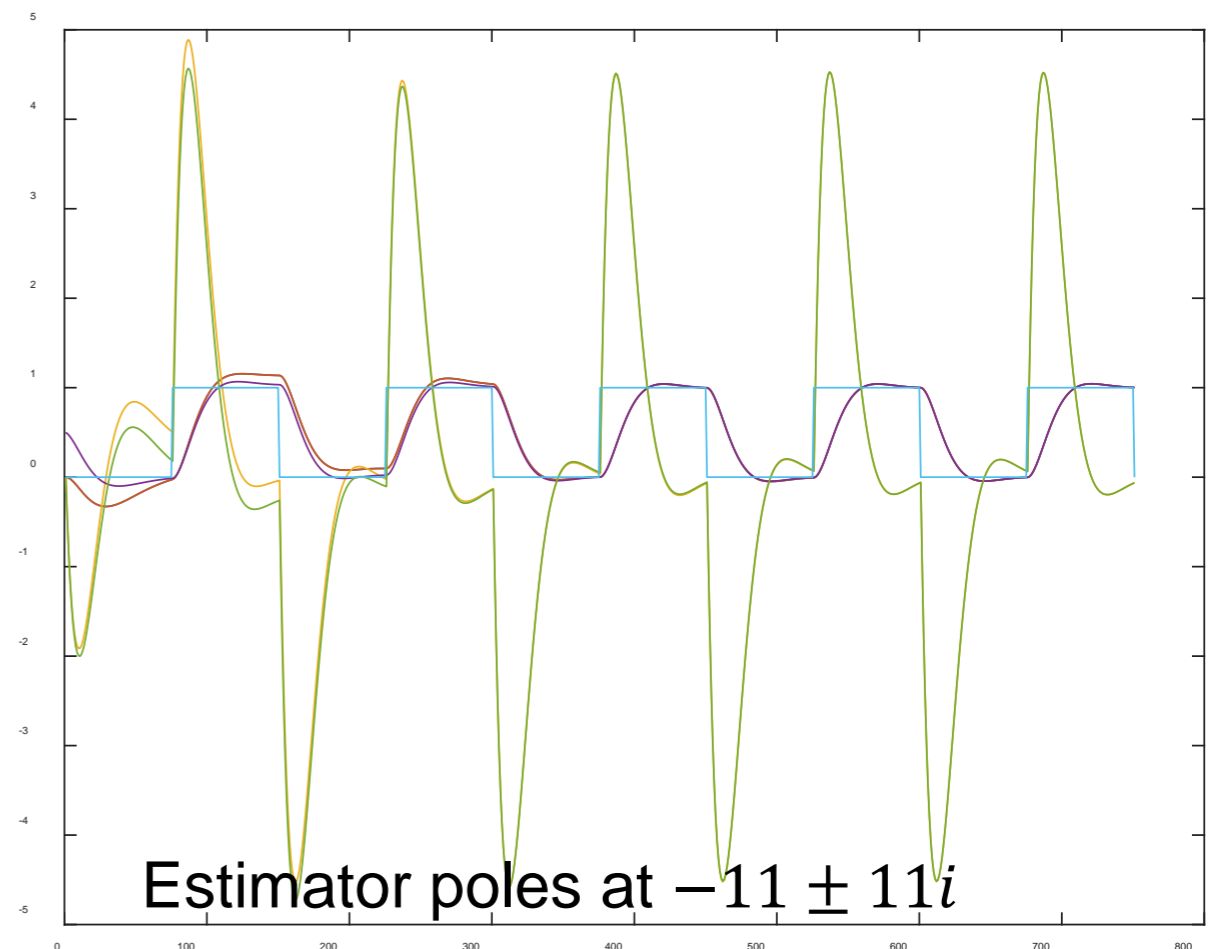

Frequency Domain Modeling

Defn. The frequency response of a linear system is the relationship between the gain and phase of a sinusoidal input and the corresponding steady state (sinusoidal) output.

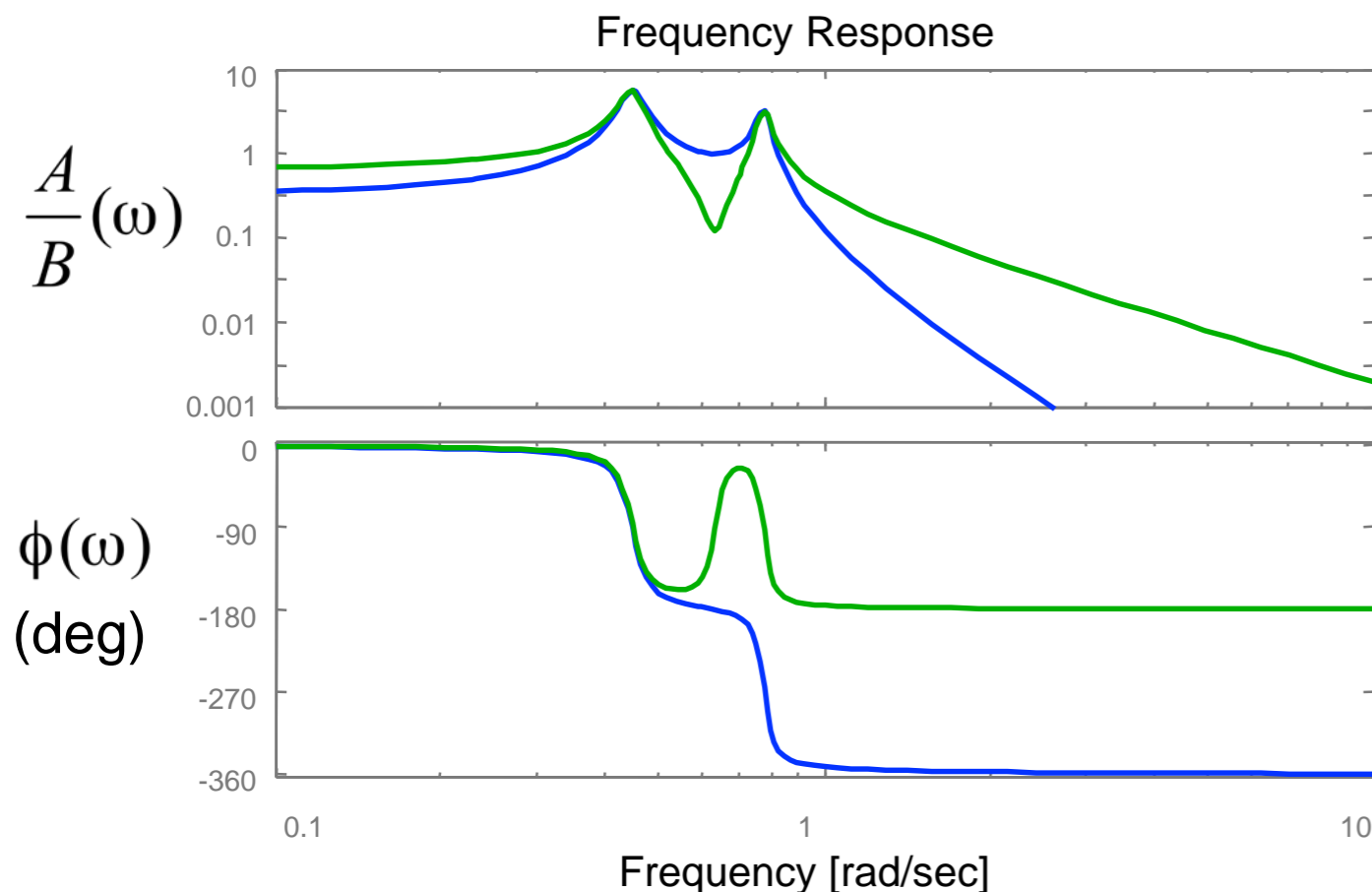
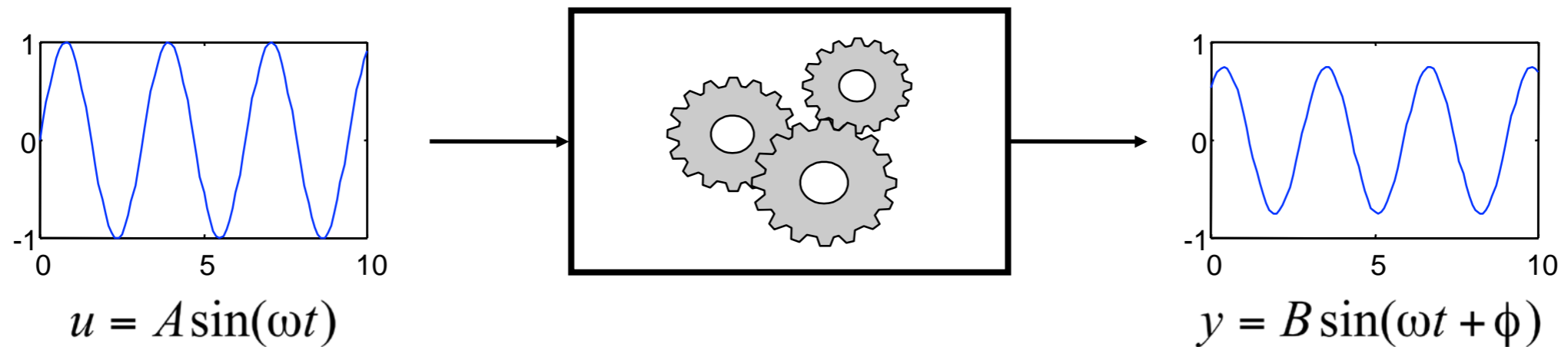

Bode plot (1940; Henrik Bode)

- Plot gain and phase vs input frequency
- Gain is plotting using log-log plot
- Phase is plotting with log-linear plot
- Can read off the system response to a sinusoid – in the lab or in simulations
- Linearity \Rightarrow can construct response to any input (via Fourier decomposition)
- Key idea: do all computations in terms of gain and phase (frequency domain)

Transmission of Exponential Signals

Exponential signal: $e^{st} = e^{(\sigma+i\omega)t} = e^{\sigma t} e^{i\omega t} = e^{\sigma t} (\cos \omega t + i \sin \omega t)$

- Construct constant inputs + sines/cosines by linear combinations

- Constant: $u(t) = c = ce^{0t}$

- Sinusoid: $u(t) = A \sin(\omega t) = \frac{A}{2i} (e^{i\omega t} - e^{-i\omega t})$

- Decaying sinusoid: $u(t) = Ae^{-\sigma t} \sin(\omega t)$

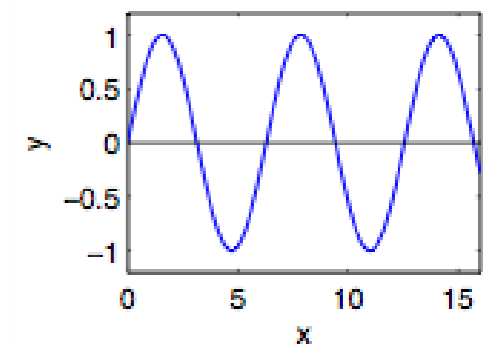
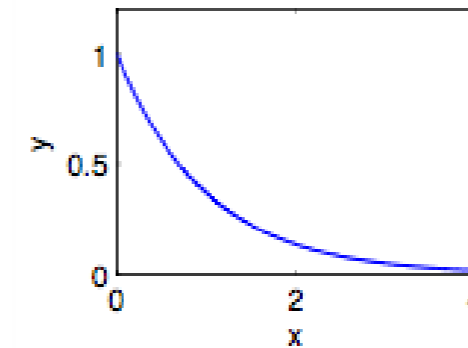

- Exponential response can be computed via the convolution equation

$$x(t) = e^{At} x(0) + \int_0^t e^{A(t-\tau)} B e^{s\tau} d\tau$$

$$= e^{At} x(0) + e^{At} (sI - A)^{-1} e^{(sI-A)\tau} \Big|_{\tau=0}^t B$$

$$= e^{At} x(0) + e^{At} (sI - A)^{-1} (e^{(sI-A)t} - I) B$$

$$= e^{At} (x(0) - (sI - A)^{-1} B) + (sI - A)^{-1} B e^{st}$$

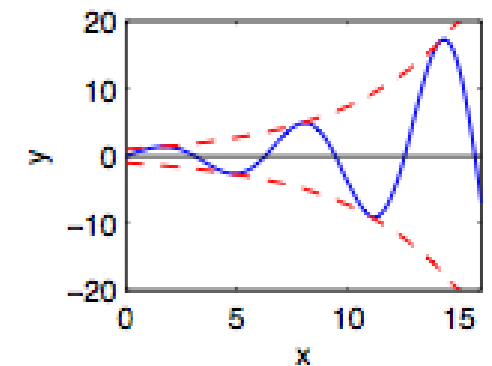
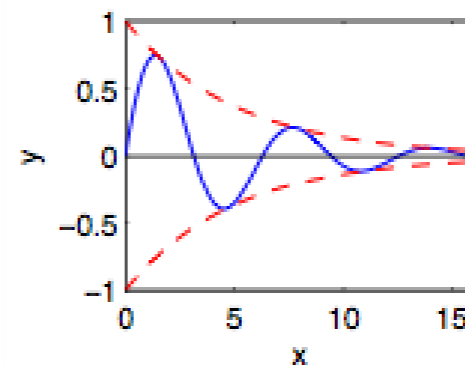

$$y(t) = Cx(t) + Du(t)$$

$$= Ce^{At} (x(0) - (sI - A)^{-1} B) + (C(sI - A)^{-1} B + D) e^{st}$$

Transfer Function and Frequency Response

Exponential response of a linear state space system

$$y(t) = \underbrace{C e^{At} \left(x(0) - (sI - A)^{-1} B \right)}_{\text{transient}} + \underbrace{\left(C(sI - A)^{-1} B + D \right) e^{st}}_{\text{steady state}}$$

Transfer function

- Steady state response is proportional to exponential input => look at input/output ratio $y(s)/u(s)$
- $G(s) = C(sI - A)^{-1} B + D$ is the transfer function between input and output
- Note response at eigenvalues of A

Frequency response

$$u(t) = A \sin \omega t = \frac{A}{2i} (e^{i\omega t} - e^{-i\omega t})$$

$$y_{ss}(t) = \frac{A}{2i} \left(G(i\omega) e^{i\omega t} - G(-i\omega) e^{-i\omega t} \right)$$

$$= A \cdot |G(i\omega)| \sin(\omega t + \arg G(i\omega))$$

gain

phase

Common transfer functions

$\dot{y} = u$	$\frac{1}{s}$
$y = \dot{u}$	s
$\dot{y} + ay = u$	$\frac{1}{s+a}$
$\ddot{y} = u$	$\frac{1}{s^2}$
$\ddot{y} + 2\zeta\omega_n\dot{y} + \omega_n^2 y = u$	$\frac{1}{s^2 + 2\zeta\omega_n s + \omega_n^2}$
$y = k_p u + k_d \dot{u} + k_i \int u$	$k_p + k_d s + \frac{k_i}{s}$
$y(t) = u(t - \tau)$	$e^{-\tau s}$

Example: Electrical Circuits

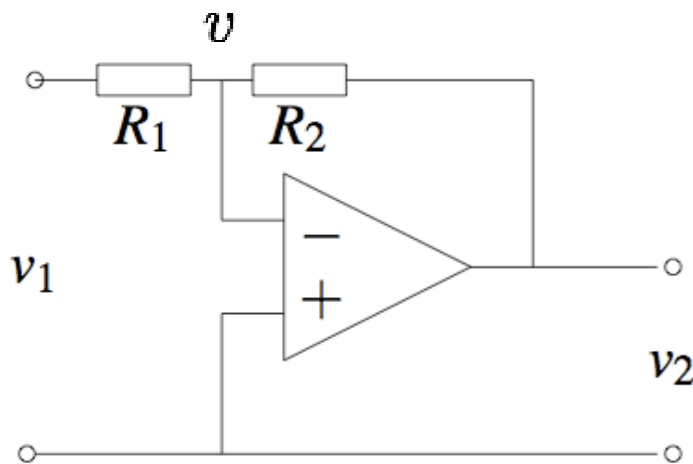

Op amp dynamics:

$$\frac{v_{\text{out}}}{v} = -\frac{ak}{s+a} =: G(s)$$

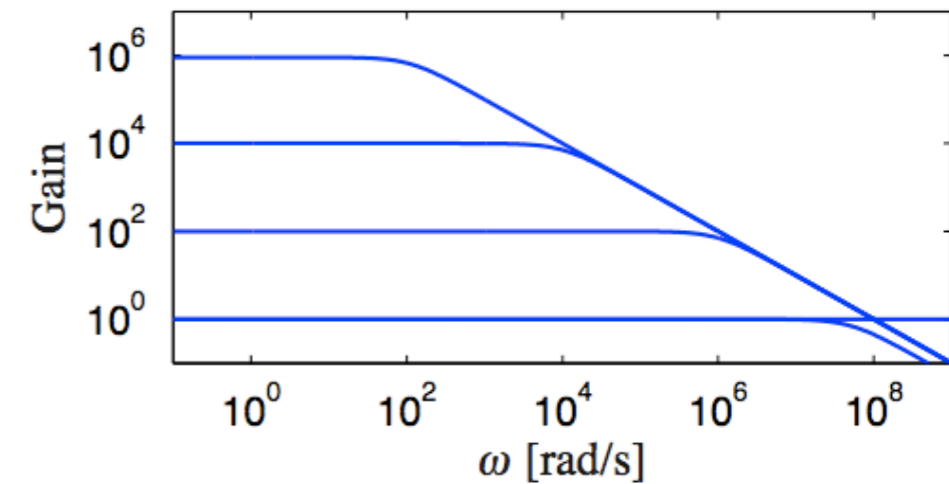

Circuit dynamics (Kirchoff's laws):

$$\frac{v_1 - v}{R_1} = \frac{v - v_2}{R_2}; \quad v_2 = G(s)v; \quad \Rightarrow \quad v = \frac{R_2 v_1 + R_1 v_2}{R_1 + R_2}$$

$$v_2 = -\frac{ak}{s+a} \left(\frac{R_2 v_1 + R_1 v}{R_1 + R_2} \right)$$

$$\frac{v_2}{v_1} = \frac{-R_2 ak}{R_1 ak + (R_1 + R_2)(s + a)}$$

- Algebraic manipulation can be used as long as we assume exponential signals and all of the components (blocks) are linear
- Transfer function between input and output show gain-bandwidth tradeoff

Transfer Function Properties

Theorem. The transfer function for a linear system $\Sigma = (A, B, C, D)$ is given by

$$G(s) = C(sI - A)^{-1} + D \quad s \in \mathbb{C}$$

Theorem. The transfer function $G(s)$ corresponding to $\Sigma = (A, B, C, D)$ has the following properties (for SISO systems):

- $G(s)$ is a ratio of polynomials $n(s)/d(s)$ where $d(s)$ is the characteristic equation for the matrix A and $n(s)$ has order less than or equal to $d(s)$.
- The steady state frequency response of Σ has gain $|G(j\omega)|$ and phase $\arg G(j\omega)$:

$$u = A \sin(\omega t)$$

$$y = |G(i\omega)| A \sin(\omega t + \arg G(i\omega)) + \text{transients}$$

Remarks

- Formally, $G(s)$ is the Laplace transform of the impulse response of Σ
- Typically we write “ $y = G(s)u$ ” for $Y(s) = G(s)U(s)$, where $Y(s)$ & $U(s)$ are Laplace transforms of $y(t)$ and $u(t)$. (Multiplication in Laplace domain corresponds to convolution.)
- MATLAB: $G = \text{ss2tf}(A, B, C, D)$